

Changeover Valves

Type 06520 - Diverter Valve



Cryogenic Diverter Valves, stainless steel, inner parts made of brass, PN50

for the installation of two safety valves,
provided for bursting disc connections,
"cleaned and degreased for oxygen service"

Part No. 06520.X.0000

Female thread connection (G) acc. to ISO 228/1

Part No. 06520.X.6***

Female thread connection NPT acc. to ANSI B 1.20.1



Available Options - on request only:

- Two extra test connections 1/4" edgeways
- Inlet: female thread (GW) 3/4"
- Outlet GA₁ with installed locking sleeve for easy positioning of safety valves
- Combination of different outlet threads GA₁ - GA₂
- **Safety lock (Part No. 55394.0043.0765)**

Applications:

Approved for air gases, vapours and cryogenic liquefied gases incl. LNG.

Working temperature: -196°C / -321°F (77K) up to +120°C / +248°F (393K)

Materials	DIN EN	ASTM
1 Body I	1.4308	A 351 CF8
2 Body II	1.4308	A 351 CF8
3 Ball	1.4571	A 276 Grade 316Ti
4 Seat rings	PCTFE	
5 Bush	CW614N	B 283 UNS C38500
6 Spring plates	1.4571	A 313 Grade 316Ti
7 Spring clamp	CW614N	B 283 UNS C38500
8 Thread ring	CW614N	B 283 UNS C38500
9 Plug	1.4408	A 351 CF8M
10 Stem	1.4301	A 276 Grade 304
11 Gland packing	Graphite / PTFE	
12 Lever	1.4308	A 351 CF8

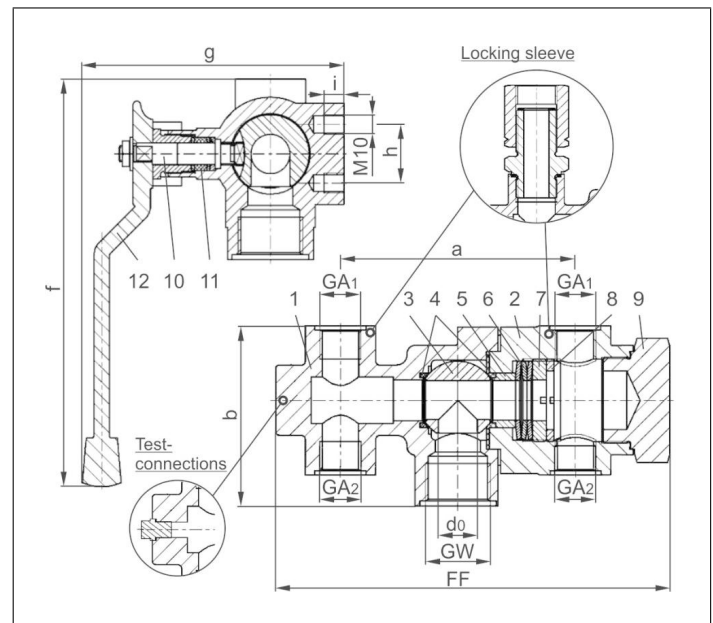

Type 06520 - Standard design	Technical Data		
Nominal Size	DN	20	20
Dimension code	.X.	2004	2006
Flow diameter	d ₀	20	20
Inlet	GW	1	1
Outlet	GA ₁	1/2	3/4
Outlet	GA ₂	1/2	1/2
Face-to-face dimension	FF	201	201
Length	a	120	120
Height	b	92	92
Length	f	208	208
Length	g	134	134
Length	h	30	30
Thread depth	i	10	10
Weight	ca. kg	4.8	4.7
Kvs - Value, one side open	m ³ /h	7.7	7.7
Cv - Value, one side open	gal /min	9.2	9.2

Dimensions in mm.

Important:

The valves must be fixed at the provided threads M10.